



SILVERSTONE[®]
Designing Inspiration

Tower Storage **TS431S**



Four bay 3.5" HDD tower with Mini-SAS SFF-8088 interface

Product Overview

• Introduction

Silverstone created an incredible base storage product in the TS431S. It connects to the PC via 6Gbps SAS/Mini-SAS interface which enables data transfer with maximum compatibility and stability, making TS431S the best choice for storing and backing up large quantity of data.

• Special Features

Support four 3.5" SATA HDD
 Built-in power supply and dual 60mm fans
 Compact and screw-less design for easy HDD installation
 Plug and Play
 Support Mini-SAS maximum 6Gbps transfer speed



• Specifications

Model No.	SST-TS431S
Enclosure Material	Aluminum + SECC
Color	Black
Power Supply	Internal universal power supply switch (115V/230V) Input: AC 100-130V/200-260V, 50Hz/60Hz Output: DC +5V/6A +12V/11A
Drive Size Support	3.5" SAS/SATA HDD/SSD
Drive Interface Support	SATA III/SATA II/SATA I/SAS*
LED Indicator	Power LED - Blue for power on HDD status LED - Blue for HDD detected Red flashing for HDD access
Enclosure Interface	Mini-SAS 8088 port x 1
Cooling FAN	60mm fan x 2
Net Weight	3300±20g
Dimension	130mm (W) x 187mm (H) x 266mm (D), 5.12" (W) x 7.36" (H) x 10.47" (D)
Certifications	CE \ FCC \ RoHS compliance
Environment	Operating Temperature: 5°C ~ 35°C Operating Humidity: 20%RH ~ 80%RH Storage Temperature: -20°C ~ 50°C Storage Humidity: 20%RH ~ 80%RH
Accessories	TS431S (hard drives not included), Power cord x 1, User manual x 1
Computer System Requirements	Windows 10/8.1/8/7 or future release version, Mac OS 10.x or future release version Linux Kernel 2.6.31 or above

* Your system must have SAS controller if you want to use SAS HDD.

* Hard drive capacity and RAID support is dependent on mini-SAS controller used.

• **Package content**

- TS431S external enclosure
- Power Cord
- User Manual

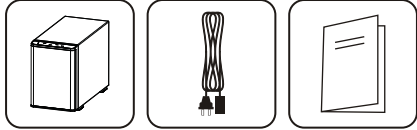

• **Hardware guide**

V1

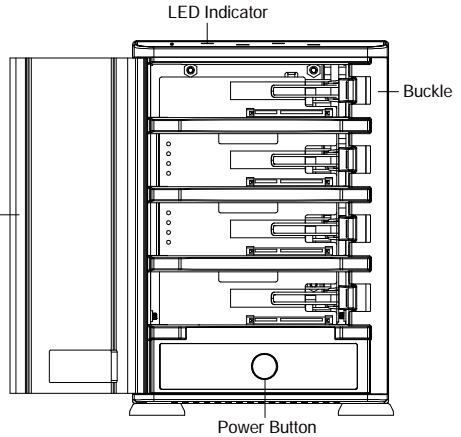
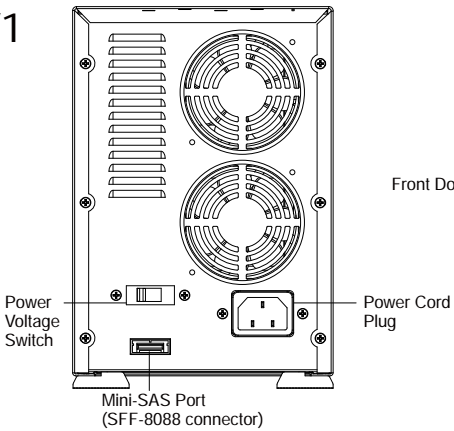

V2

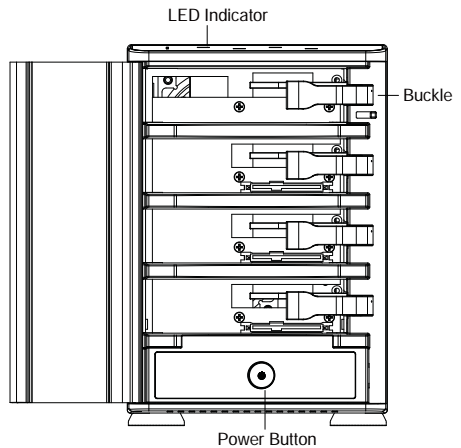
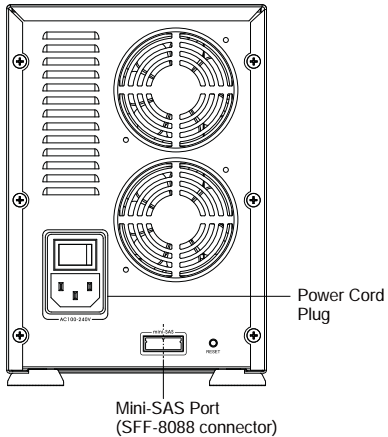

Hard drive installation

1 (Ref. Product TS431S V1)

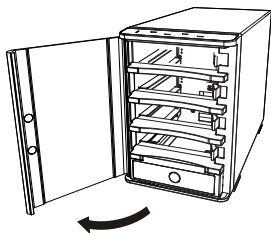

ENGLISH
Open the front door

РУССКИЙ
Откройте переднюю дверцу

DEUTSCH
Öffnen Sie die Frontklappe

繁體中文
打開前門

FRANÇAIS
Ouvrez la porte d'accès frontal

簡體中文
打开前门

ESPAÑOL
Abra la puerta frontal

日本語
フロントドアを開く

ITALIANO
Aprire il portello frontale

한국어
프론트 도어를 열고

2 (Ref. Product TS431S V1)

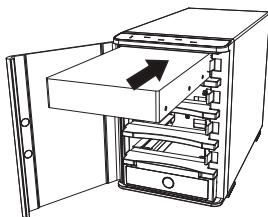

ENGLISH
Slide the HDD in until the latch click

РУССКИЙ
Переместите жесткий диск до щелчка

DEUTSCH
Festplatte bis zum Einrasten des Riegels hineinschieben

繁體中文
將硬碟小心地放入硬碟槽，
往內推直到固定卡榫扣上

FRANÇAIS
Faites glisser le disque dur à l'intérieur jusqu'à ce que vous entendiez le clic de verrouillage

簡體中文
將硬碟小心地放入硬碟槽，
往內推直到固定卡榫扣上

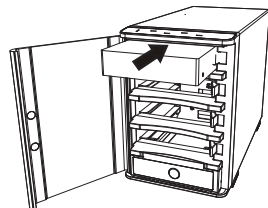

ESPAÑOL
Deslice el disco duro hasta que el pestillo haga clic

日本語
ラッチがカチッと鳴るまでHDD
をスライドさせます

ITALIANO
Far scorrere l'unità HDD finché la serratura scatta

한국어
래치가 잘락 소리를 낼 때까지 HDD
를 밀어 넣으십시오

Hard drive installation

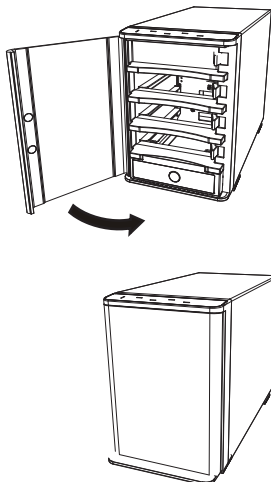
3 (Ref. Product TS431S V1)**ENGLISH**

Close the front door

РУССКИЙ

близко переднюю дверцу

DEUTSCH

Schließen Sie die Frontklappe

繁體中文
關閉前門**FRANÇAIS**

Fermer la porte d'accès frontal

簡體中文
关闭前门**ESPAÑOL**

Cerrar la puerta frontal

日本語
フロントドアを閉める**ITALIANO**

Chiudere il portello frontale

한국어
프론트 도어를 닫습니다**Caution**

(Ref. Product TS431S V1)

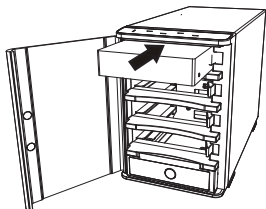
**ENGLISH**

The HDD might be damaged if not installed correctly

РУССКИЙ

Если жесткий диск не устанавливается надлежащим образом, возможно, он поврежден

DEUTSCH

Bei unsachgemäßer Installation kann die Festplatte beschädigt werden

繁體中文
請注意：如果沒有正確的安裝硬碟，硬碟將有可能會損壞。**FRANÇAIS**

Le disque dur peut-être endommagé s'il n'est pas installé correctement

簡體中文
請注意：如果沒有正確的安裝硬碟，硬碟將有可能會損壞。**ESPAÑOL**

El disco duro podría resultar dañado si no se instala correctamente

日本語
正しく取り付けていない場合、HDDが損傷する可能性があります**ITALIANO**

L'unità HDD potrebbe subire danni se non è installata correttamente.

한국어

올바로 설치하지 않을 경우 HDD가 손상될 수 있습니다

Hard drive installation

Remove the HDD

(Ref. Product TS431S V1)

ENGLISH

Open the door and release the latch. The HDD will pop out slightly then pull the HDD out gently with your hands.

DEUTSCH

Öffnen Sie die Tür, geben Sie den Riegel frei. Die Festplatte springt ein Stück heraus; ziehen Sie die Festplatte vorsichtig von Hand raus.

FRANÇAIS

Ouvrez la porte et libérez le verrou. Le disque dur sera doucement éjecté puis tirez légèrement le disque dur vers l'extérieur avec vos mains.

ESPAÑOL

Abra la puerta y quite el pestillo. El disco duro saldrá ligeramente, luego tire con suavidad del disco duro con sus manos.

ITALIANO

Aprire lo sportello e sbloccare la serratura. L'unità HDD uscirà leggermente; estrarre delicatamente l'unità HDD con le mani.

РУССКИЙ

Откройте крышку и освободите фиксатор. После того как жесткий диск слегка выступит, осторожно извлеките его руками.

繁體中文

移除硬碟
打開前門，按壓固定卡榫讓硬碟退出；然後小心地將硬碟取出。

簡體中文

移除硬盘
打开前门，按压固定卡榫让硬盘退出；然后小心地将硬盘取出。

日本語

ドアを開き、ラッチを解除します。HDDがわずかに飛び出したら、両手でHDDをそっと引き出します。

한국어

도어를 열고 래치를 해제하십시오. HDD가 약간 튀어 나오면 손으로 HDD를 천천히 당겨 빼십시오.

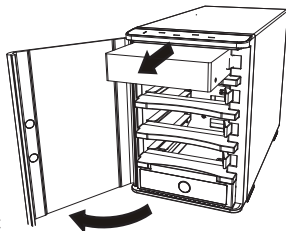

Connect to PC

ENGLISH

Connect power cable and the Mini-SAS cable and switch on the power.

DEUTSCH

Schließen Sie Netz- und Mini-SAS-Kabel an, schalten Sie das Gerät ein.

FRANÇAIS

Branchez le câble d'alimentation et le câble Mini-SAS et mettez en marche.

ESPAÑOL

Conecte el cable de corriente y el cable Mini-SAS y conecte la corriente

ITALIANO

Collegare il cavo d'alimentazione ed il cavo mini-SAS, quindi accendere l'alimentazione.

РУССКИЙ

Подключите кабель питания и кабель Mini-SAS и включите питание.

繁體中文

將電源線與Mini-SAS線分別接上，確定線材全部接受後，開啓電源。

簡體中文

将电源线与Mini-SAS线分别接上，确定线材全部接受后，开启电源。

日本語

電源ケーブルとミニSASケーブルを接続し、電源のスイッチを入れます。

한국어

전원 케이블과 Mini-SAS 케이블을 연결하고 전원을 켜십시오.

Warranty information

This product has a limited 1 year warranty in North America and Australia.

For information on warranty periods in other regions, please contact your reseller or SilverStone authorized distributor.

本产品自购买之日起，于中国地区（不包含澳门，香港特别行政区）享有一年有限责任保固（部分产品为二年，三年或五年）。详细保固年限请参照官方网站 www.silverstonetek.com.cn 公布之产品型号为依据。

Warranty terms & conditions

- Product component defects or damages resulted from defective production is covered under warranty.
Defects or damages with the following conditions will be fixed or replaced under SilverStone Technology's jurisdiction.
 - Usage in accordance with instructions provided in this manual, with no misuse, overuse, or other inappropriate actions.
 - Damage not caused by natural disaster (thunder, fire, earthquake, flood, salt, wind, insect, animals, etc...)
 - Product is not disassembled, modified, or fixed. Components not disassembled or replaced.
 - Warranty mark/stickers are not removed or broken.

Loss or damages resulted from conditions other than ones listed above are not covered under warranty.
- Under warranty, SilverStone Technology's maximum liability is limited to the current market value for the product (depreciated value, excluding shipping, handling, and other fees). SilverStone Technology is not responsible for other damages or loss associated with the use of product.
- Under warranty, SilverStone Technology is obligated to repair or replace its defective products. Under no circumstances will SilverStone Technology be liable for damages in connection with the sale, purchase, or use including but not limited to loss of data, loss of business, loss of profits, loss of use of the product or incidental or consequential damage whether or not foreseeable and whether or not based on breach of warranty, contract or negligence, even if SilverStone Technology has been advised of the possibility of such damages.
- Warranty covers only the original purchaser through authorized SilverStone distributors and resellers and is not transferable to a second hand purchaser.
- You must provide sales receipt or invoice with clear indication of purchase date to determine warranty eligibility.
- If a problem develops during the warranty period, please contact your retailer/reseller/SilverStone authorized distributors or SilverStone <http://www.silverstonetek.com>.
Please note that: (i) You must provide proof of original purchase of the product by a dated itemized receipt; (ii) You shall bear the cost of shipping (or otherwise transporting) the product to SilverStone authorized distributors. SilverStone authorized distributors will bear the cost of shipping (or otherwise transporting) the product back to you after completing the warranty service; (iii) Before you send the product, you must be issued a Return Merchandise Authorization ("RMA" number from SilverStone. Updated warranty information will be posted on SilverStone's official website. Please visit <http://www.silverstonetek.com> for the latest updates.

Additional info & contacts

For North America (usasupport@silverstonetek.com)

SilverStone Technology in North America may repair or replace defective product with refurbished product that is not new but has been functionally tested. Replacement product will be warranted for remainder of the warranty period or thirty days, whichever is longer. All products should be sent back to the place of purchase if it is within 30 days of purchase, after 30 days, customers need to initiate RMA procedure with SilverStone Technology in USA by first downloading the "USA RMA form for end-users" form from the below link and follow its instructions.

<http://silverstonetek.com/contactus.php>

For Australia only (support@silverstonetek.com)

Our goods come with guarantees that cannot be excluded under the Australian Consumer Law.

You are entitled to a replacement or refund for a major failure and for compensation for any other reasonably foreseeable loss or damage.

You are also entitled to have the goods repaired or replaced if the goods fail to be of acceptable quality and the failure does not amount to a major failure.

Please refer to above "Warranty terms & conditions" for further warranty details.

SilverStone Technology Co., Ltd. 12F No. 168 Jiankang Rd., Zhonghe Dist., New Taipei City 235 Taiwan R.O.C. + 886-2-8228-1238

(standard international call charges apply)

For Europe (support.eu@silverstonetek.de)

For China (support@silverstonetek.com.cn)

For all other regions (support@silverstonetek.com)

有毒有害物质/元素及其化学含量表

部件名称	铅 (Pb)	汞 (Hg)	镉 (Cd)	六价铬 (Cr(VI))	多溴联苯 (PBB)	多溴二苯醚 (PBDE)
铝壳	○	○	○	○	○	○
电子卡	○	○	○	○	○	○
线材	○	○	○	○	○	○
螺丝	○	○	○	○	○	○
包材	○	○	○	○	○	○

○：表示该有毒有害物质在该部件所有均质材料中的含量均在SJ/T11364-2014标准规定的限量要求以下。

×：表示该有毒有害物质在该部件材料中的含量超出SJ/T11364-2014标准规定的限量要求。

本表中有×的部件均符合欧盟RoHS法规，即欧盟第2011/65/EU号指令要求。



产品合格证

检验员：检01

生产日期：见产品条码

SilverStone Technology Co., Ltd.

www.silverstonetek.com

support@silverstonetek.com

NO: G11232760